



HVAC Products

SUBMITTAL

Mar 2018

311 SERIES EXPANSION JOINT 3" TRAVEL W/WELD ENDS & TIE RODS

PROJECT:	
CUSTOMER:	
ENGINEER:	
ARCHITECT:	

MATERIALS OF CONSTRUCTION	
'A' PIPE SCH 40:	CARBON STEEL
'B' CAPSULE:	T-304 STN STL
'C' PLATE FLANGE:	CARBON STEEL
'D' TIE RODS/SPACERS	CARBON STEEL

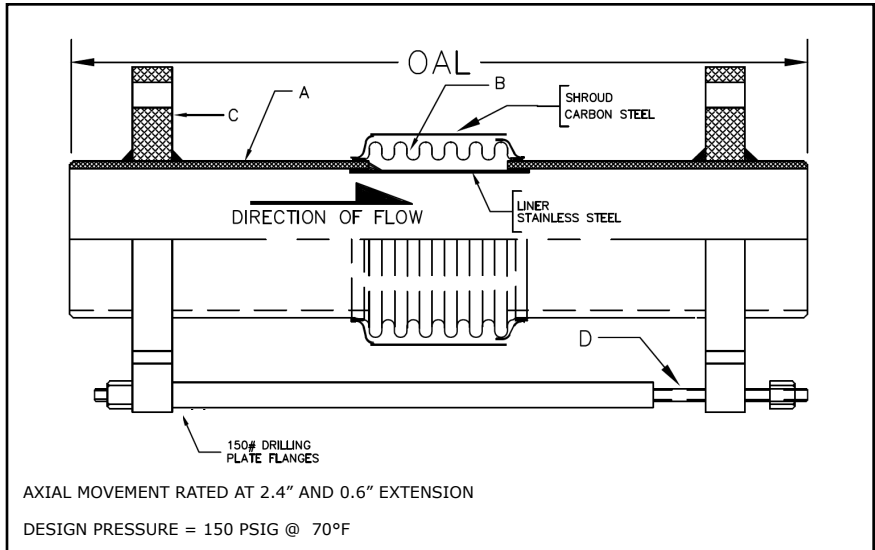

QTY	ID # OR TAG #	DIA (IN)	KEFLEX PART #	OAL	AXIAL FORCE TO COMPRESS (LBS)	WEIGHT (LBS)	3D Model (.stp)
		2"	F020M311T903	20"	200	31	
		2 1/2"	F024M311T903	20"	400	36	
		3"	F030M311T903	20"	300	41	
		4"	F040M311T903	20"	700	50	
		5"	F050M311T903	20"	425	66	
		6"	F060M311T903	20"	500	78	
		8"	F080M311T903	20"	750	120	
		10"	F100M311T903	20"	1000	158	
		12"	F120M311T903	20"	600	211	

Typical Installation

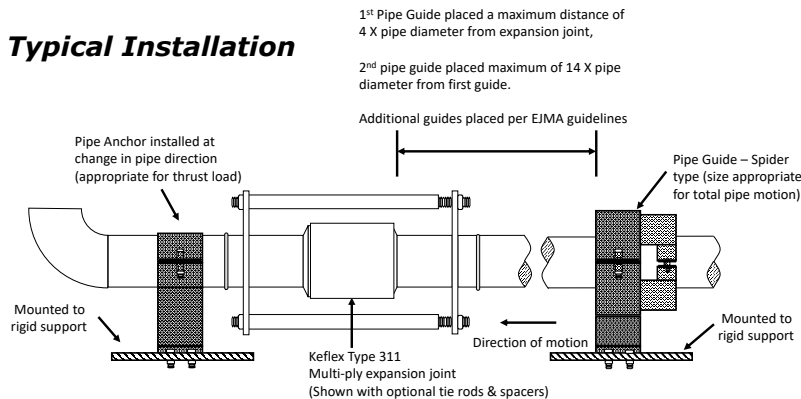

IMPORTANT LINKS

BROCHURE:	
INSTALLATION INSTRUCTIONS:	
TECHNICAL DATA:	
WEBSITE:	FLEX-WELD.COM



MADE IN THE USA

1425 LAKE AVE
WOODSTOCK, IL 60098
800-323-6893