



HVAC Products

SUBMITTAL

Mar 2018

311 SERIES EXPANSION JOINT 2" TRAVEL W/WELD ENDS & TIE RODS

PROJECT:	
CUSTOMER:	
ENGINEER:	
ARCHITECT:	

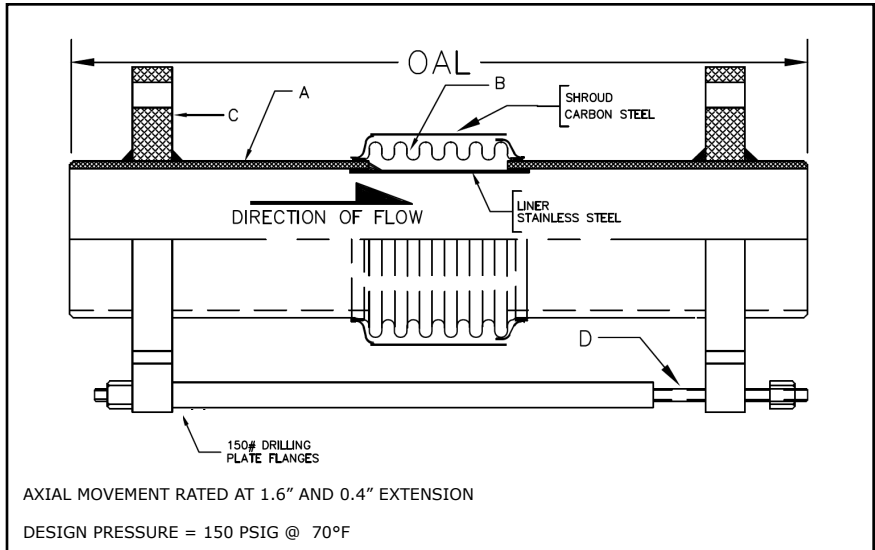

MATERIALS OF CONSTRUCTION	
'A' PIPE SCH 40:	CARBON STEEL
'B' CAPSULE:	T-304 STN STL
'C' PLATE FLANGE:	CARBON STEEL
'D' TIE RODS/SPACERS	CARBON STEEL

QTY	ID # OR TAG #	DIA (IN)	KEFLEX PART #	OAL	AXIAL FORCE TO COMPRESS (LBS)	WEIGHT (LBS)	3D Model (.stp)
		2"	F020M311T902	17"	175	29	
		2 1/2"	F024M311T902	17"	350	35	
		3"	F030M311T902	17"	225	40	
		4"	F040M311T902	17"	575	51	
		5"	F050M311T902	17"	350	65	
		6"	F060M311T902	17"	400	80	
		8"	F080M311T902	17"	575	117	
		10"	F100M311T902	17"	850	154	
		12"	F120M311T902	17"	475	209	

Typical Installation

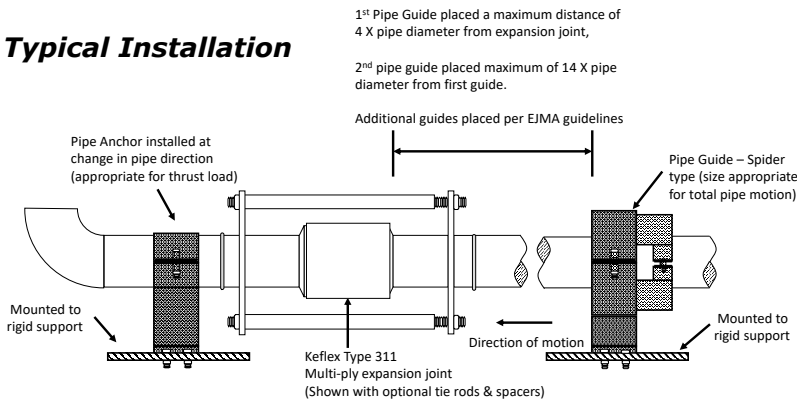

IMPORTANT LINKS

BROCHURE:	
INSTALLATION INSTRUCTIONS:	
TECHNICAL DATA:	
WEBSITE:	FLEX-WELD.COM



MADE IN THE USA

**1425 LAKE AVE
WOODSTOCK, IL 60098
800-323-6893**