



HVAC Products

SUBMITTAL

Mar 2018

311 SERIES EXPANSION JOINT 1" TRAVEL W/WELD ENDS & TIE RODS

PROJECT:	
CUSTOMER:	
ENGINEER:	
ARCHITECT:	

MATERIALS OF CONSTRUCTION	
'A' PIPE SCH 40:	CARBON STEEL
'B' CAPSULE:	T-304 STN STL
'C' PLATE FLANGE:	CARBON STEEL
'D' TIE RODS/SPACERS	CARBON STEEL

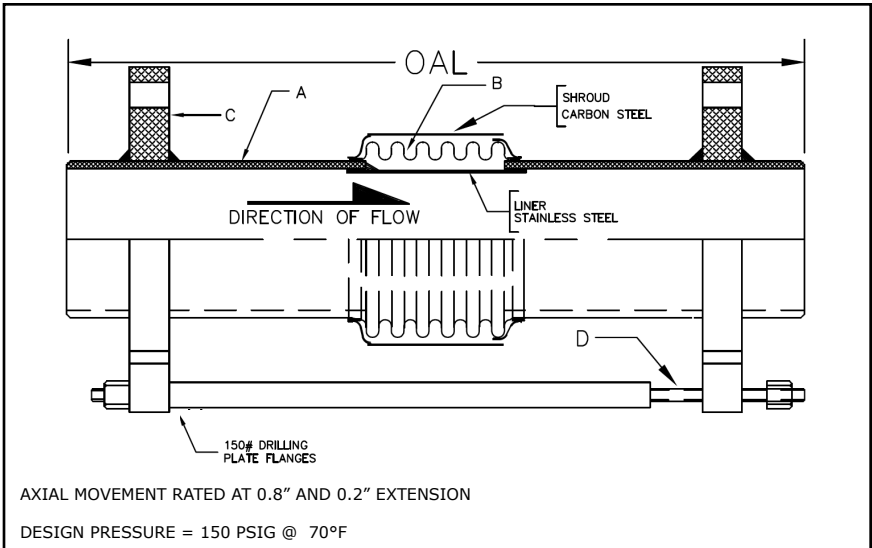

QTY	ID # OR TAG #	DIA (IN)	KEFLEX PART #	OAL	AXIAL FORCE TO COMPRESS (LBS)	WEIGHT (LBS)	3D Model (.stp)
		2"	F020M311T901	15"	100	27	
		2 1/2"	F024M311T901	15"	200	32	
		3"	F030M311T901	15"	150	37	
		4"	F040M311T901	15"	400	47	
		5"	F050M311T901	15"	225	62	
		6"	F060M311T901	15"	250	76	
		8"	F080M311T901	15"	400	112	
		10"	F100M311T901	15"	600	144	
		12"	F120M311T901	15"	350	198	

Typical Installation

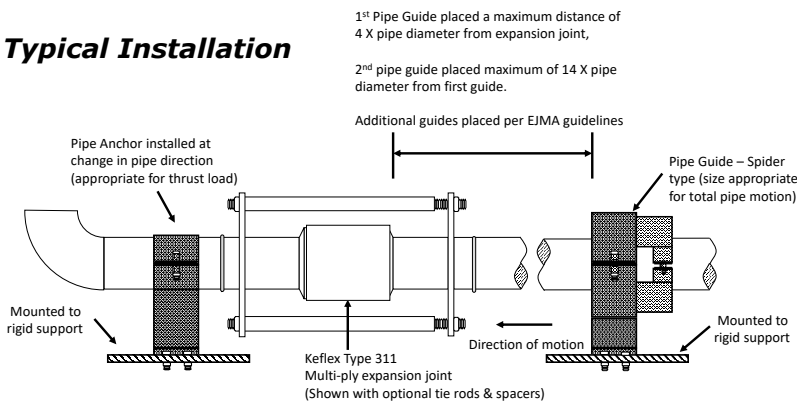

IMPORTANT LINKS

BROCHURE:	
INSTALLATION INSTRUCTIONS:	
TECHNICAL DATA:	
WEBSITE:	FLEX-WELD.COM



MADE IN THE USA

**1425 LAKE AVE
WOODSTOCK, IL 60098
800-323-6893**