



HVAC Products

SUBMITTAL

Mar 2018

311 SERIES DUAL EXPANSION JOINT 2" TRAVEL W/WELD ENDS & TIE RODS

PROJECT:	
CUSTOMER:	
ENGINEER:	
ARCHITECT:	

MATERIALS OF CONSTRUCTION	
'A' PIPE SCH 40:	CARBON STEEL
'B' CAPSULE:	T-304 STN STL
'C' TIE RODS/SPACERS:	CARBON STEEL
'D' PLATE FLANGES:	CARBON STEEL

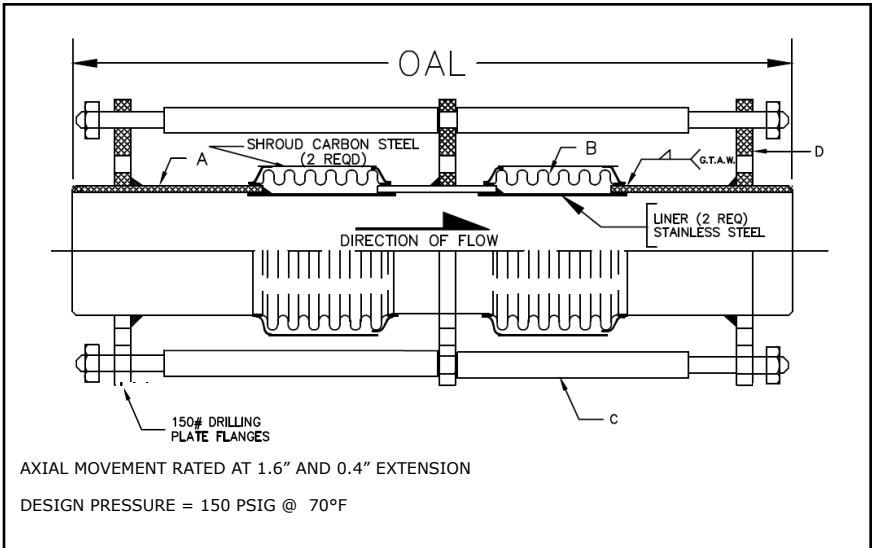

QTY	ID # OR TAG #	DIA (IN)	KEFLEX PART #	OAL	AXIAL FORCE TO COMPRESS (LBS)	WEIGHT (LBS)	3D Model (.stp)
		2"	F020M311DT902	25"	100	43	
		2 1/2"	F024M311DT902	25"	200	45	
		3"	F030M311DT902	25"	150	66	
		4"	F040M311DT902	25"	400	84	
		5"	F050M311DT902	25"	225	103	
		6"	F060M311DT902	25"	250	120	
		8"	F080M311DT902	25"	400	161	
		10"	F100M311DT902	25"	600	203	
		12"	F120M311DT902	25"	350	277	

Typical Installation

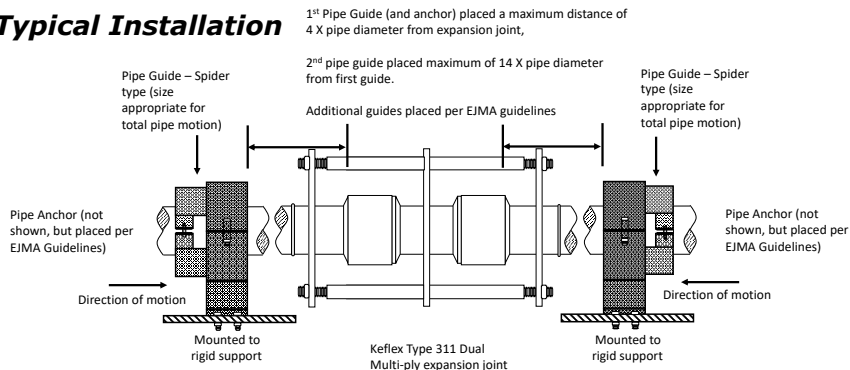

IMPORTANT LINKS

BROCHURE:	
INSTALLATION INSTRUCTIONS:	
TECHNICAL DATA:	
WEBSITE:	FLEX-WELD.COM



MADE IN THE USA

**1425 LAKE AVE
WOODSTOCK, IL 60098
800-323-6893**