



HVAC Products

SUBMITTAL

Mar 2018

311 SERIES EXPANSION JOINT 2" TRAVEL W/300# PLATE FLANGES & TIE RODS

PROJECT:	
CUSTOMER:	
ENGINEER:	
ARCHITECT:	

MATERIALS OF CONSTRUCTION	
'A' PIPE SCH 40:	CARBON STEEL
'B' CAPSULE:	T-304 STN STL
'C' PLATE FLANGE:	CARBON STEEL
'D' TIE RODS/SPACERS	CARBON STEEL

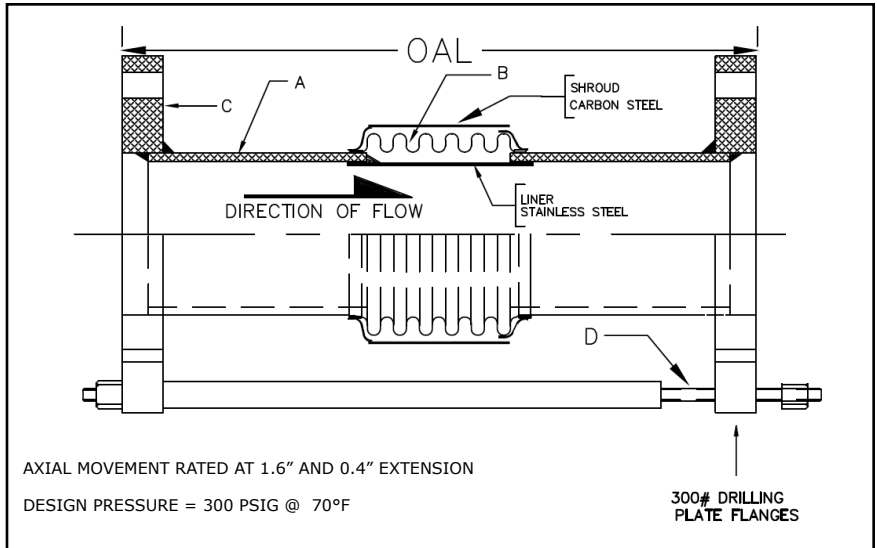

QTY	ID # OR TAG #	DIA (IN)	KEFLEX PART #	OAL	AXIAL FORCE TO COMPRESS (LBS)	WEIGHT (LBS)	3D Model (.stp)
		2"	F020H311T3002	17"	175	45	
		2 1/2"	F024H311T3002	17"	350	53	
		3"	F030H311T3002	17"	225	59	
		4"	F040H311T3002	17"	575	72	
		5"	F050H311T3002	17"	350	88	
		6"	F060H311T3002	17"	400	107	
		8"	F080H311T3002	17"	575	152	
		10"	F100H311T3002	17"	850	189	
		12"	F120H311T3002	17"	475	259	

Typical Installation

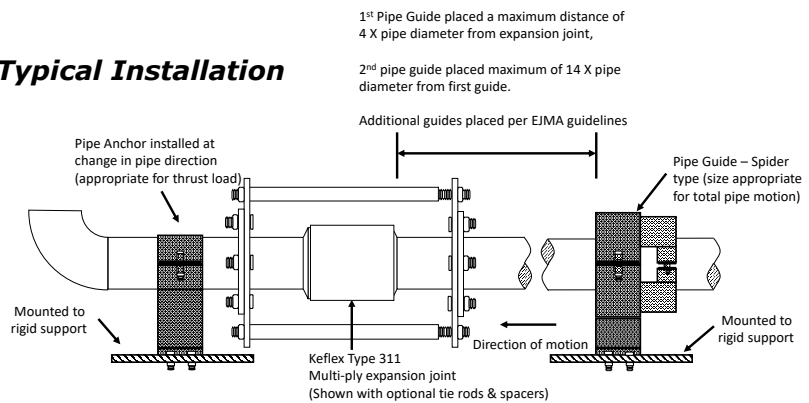

IMPORTANT LINKS	
BROCHURE:	
INSTALLATION INSTRUCTIONS:	
TECHNICAL DATA:	
WEBSITE:	FLEX-WELD.COM

MADE IN THE USA

**1425 LAKE AVE
WOODSTOCK, IL 60098
800-323-6893**