



HVAC Products

# SUBMITTAL

Mar 2018

## 308 SERIES EXPANSION JOINT 1" TRAVEL W/150# PLATE FLANGES & TIE RODS

<b>PROJECT:</b>	
<b>CUSTOMER:</b>	
<b>ENGINEER:</b>	
<b>ARCHITECT:</b>	

MATERIALS OF CONSTRUCTION	
'A' PIPE SCH 40:	CARBON STEEL
'B' CAPSULE:	T-304 STN STL
'C' PLATE FLANGE:	CARBON STEEL
'D' TIE RODS/SPACERS	CARBON STEEL

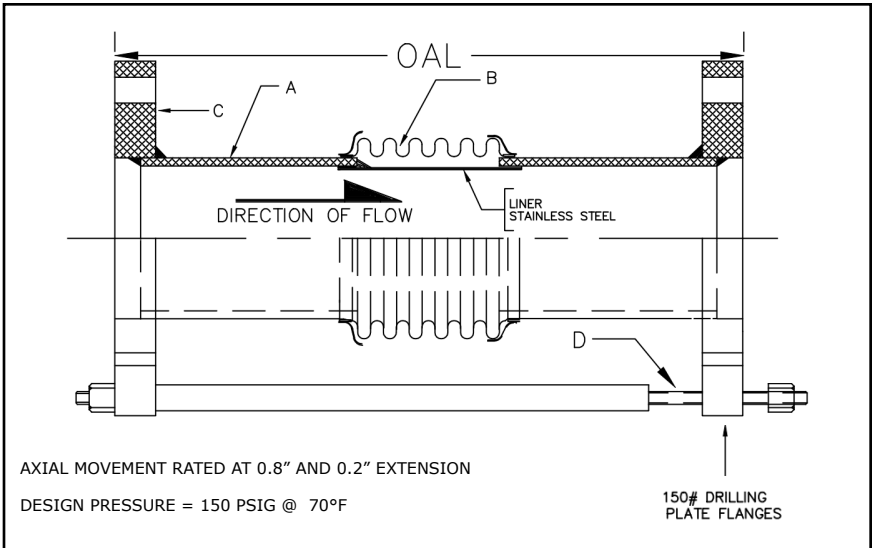

QTY	ID # OR TAG #	DIA (IN)	KEFLEX PART #	OAL	AXIAL FORCE TO COMPRESS (LBS)	WEIGHT (LBS)	3D Model (.stp)
		2"	F020M308T1501	13"	100	26	
		2 1/2"	F024M308T1501	13"	200	31	
		3"	F030M308T1501	13"	150	35	
		4"	F040M308T1501	13"	400	43	
		5"	F050M308T1501	13"	225	57	
		6"	F060M308T1501	13"	250	70	
		8"	F080M308T1501	13"	400	106	
		10"	F100M308T1501	13"	600	138	
		12"	F120M308T1501	13"	350	192	

### Typical Installation

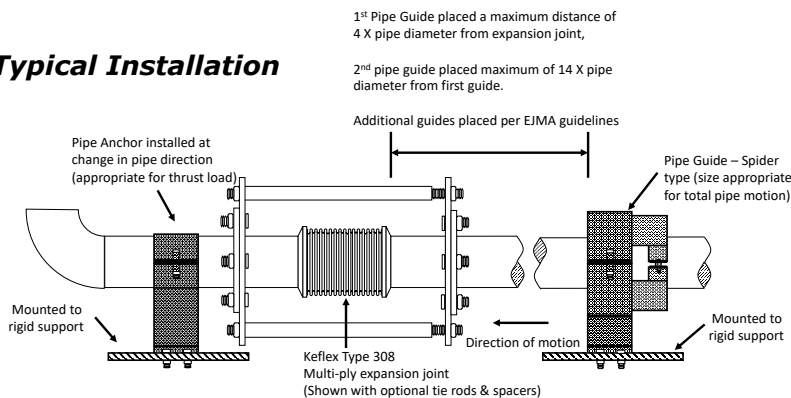

### IMPORTANT LINKS

BROCHURE:	
INSTALLATION INSTRUCTIONS:	
TECHNICAL DATA:	
WEBSITE:	<a href="http://FLEX-WELD.COM">FLEX-WELD.COM</a>



MADE IN THE USA

**1425 LAKE AVE  
WOODSTOCK, IL 60098  
800-323-6893**