

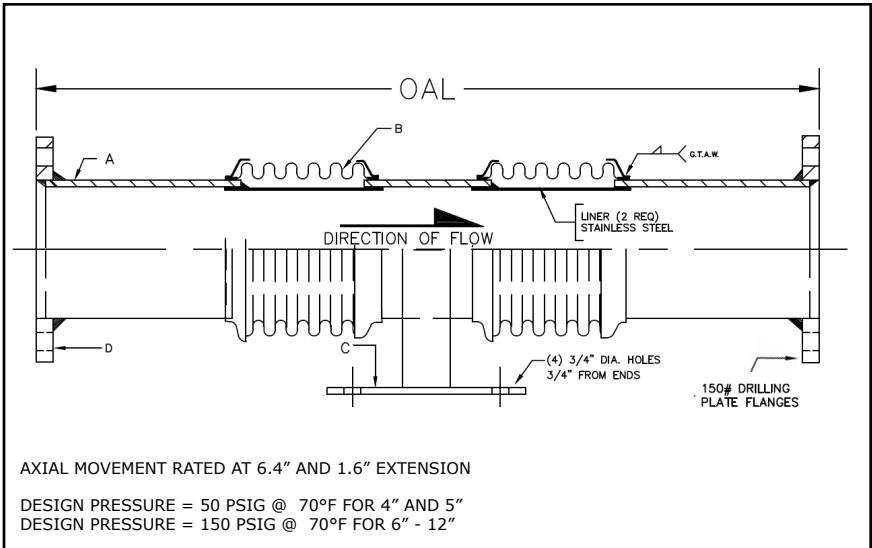





## 308 SERIES DUAL EXPANSION JOINT 8" TRAVEL W/150# PLATE FLANGES

<b>PROJECT:</b>	
<b>CUSTOMER:</b>	
<b>ENGINEER:</b>	
<b>ARCHITECT:</b>	

MATERIALS OF CONSTRUCTION	
'A' PIPE SCH 40:	CARBON STEEL
'B' CAPSULE:	T-304 STN STL
'C' BASE PLATE:	CARBON STEEL
'D' PLATE FLANGES:	CARBON STEEL



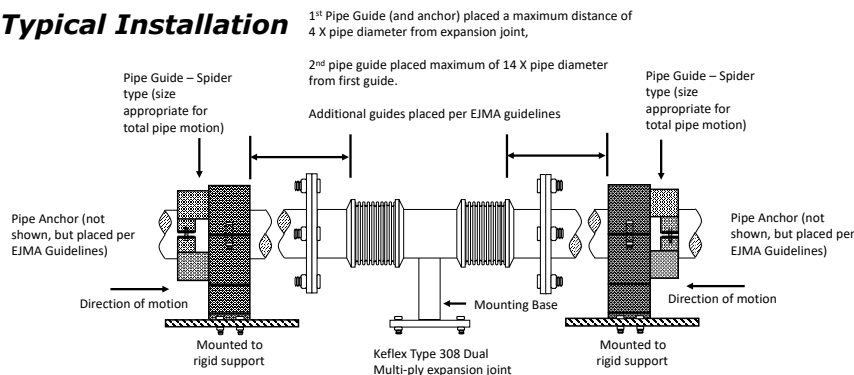

QTY	ID # OR TAG #	DIA (IN)	KEFLEX PART #	OAL	AXIAL FORCE TO COMPRESS (LBS)	WEIGHT (LBS)	3D Model (.stp)
		4"	F040L308DB1508	40"	625	76	
		5"	F050L308DB1508	40"	425	91	
		6"	F060M308DB1508	40"	500	107	
		8"	F080M308DB1508	40"	650	143	
		10"	F100M308DB1508	40"	900	180	
		12"	F120M308DB1508	40"	550	245	

### Typical Installation



### IMPORTANT LINKS

BROCHURE:	
INSTALLATION INSTRUCTIONS:	
TECHNICAL DATA:	
WEBSITE:	<a href="http://FLEX-WELD.COM">FLEX-WELD.COM</a>



MADE IN THE USA

**1425 LAKE AVE  
WOODSTOCK, IL 60098  
800-323-6893**