



HVAC Products

SUBMITTAL

Mar 2018

308 SERIES DUAL EXPANSION JOINT 6" TRAVEL W/150# PLATE FLANGES

PROJECT:	
CUSTOMER:	
ENGINEER:	
ARCHITECT:	

MATERIALS OF CONSTRUCTION	
'A' PIPE SCH 40:	CARBON STEEL
'B' CAPSULE:	T-304 STN STL
'C' BASE PLATE:	CARBON STEEL
'D' PLATE FLANGES:	CARBON STEEL

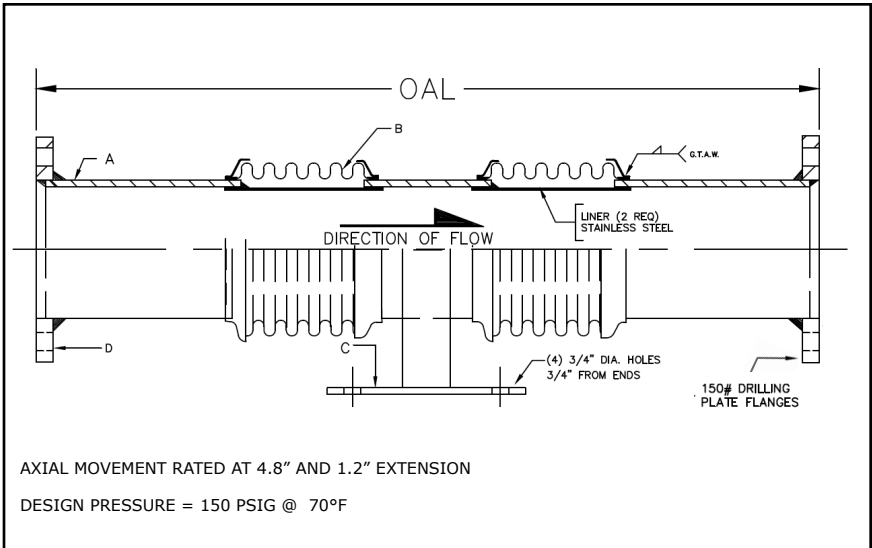

QTY	ID # OR TAG #	DIA (IN)	KEFLEX PART #	OAL	AXIAL FORCE TO COMPRESS (LBS)	WEIGHT (LBS)	3D Model (.stp)
		2"	F020M308DB1506	30"	200	32	
		2 1/2"	F024M308DB1506	30"	400	32	
		3"	F030M308DB1506	30"	300	55	
		4"	F040M308DB1506	30"	700	72	
		5"	F050M308DB1506	30"	425	87	
		6"	F060M308DB1506	30"	500	104	
		8"	F080M308DB1506	30"	750	139	
		10"	F100M308DB1506	30"	1000	176	
		12"	F120M308DB1506	30"	600	240	

Typical Installation

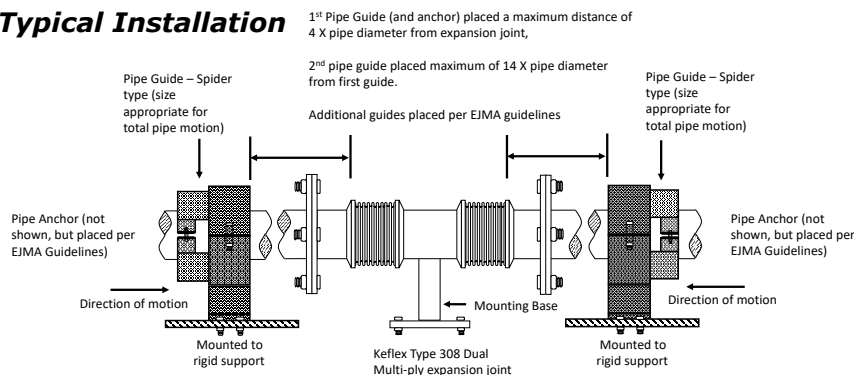

IMPORTANT LINKS

BROCHURE:	
INSTALLATION INSTRUCTIONS:	
TECHNICAL DATA:	
WEBSITE:	FLEX-WELD.COM



MADE IN THE USA

1425 LAKE AVE
WOODSTOCK, IL 60098
800-323-6893