

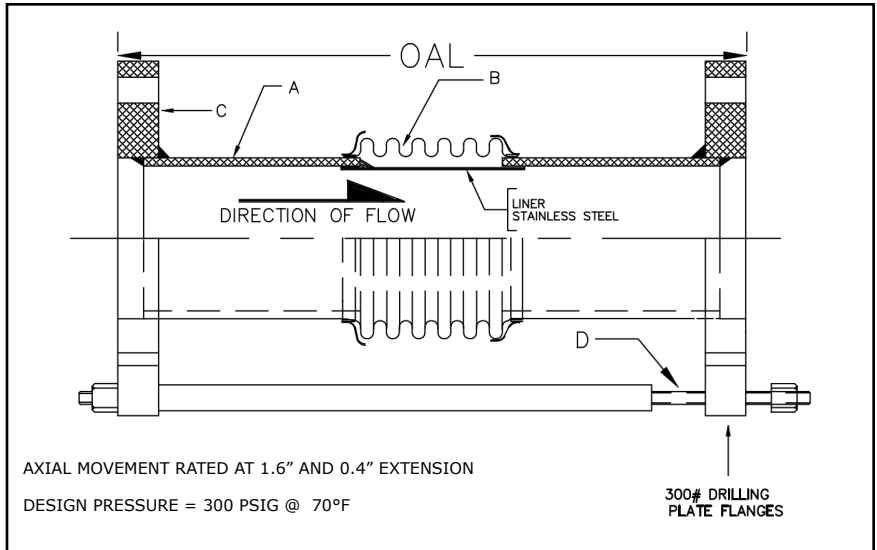









**308 SERIES EXPANSION JOINT 2" TRAVEL W/300# PLATE FLANGES & TIE RODS**

<b>PROJECT:</b>	
<b>CUSTOMER:</b>	
<b>ENGINEER:</b>	
<b>ARCHITECT:</b>	





MATERIALS OF CONSTRUCTION	
'A' PIPE SCH 40:	CARBON STEEL
'B' CAPSULE:	T-304 STN STL
'C' PLATE FLANGE:	CARBON STEEL
'D' TIE RODS/SPACERS	CARBON STEEL

QTY	ID # OR TAG #	DIA (IN)	KEFLEX PART #	OAL	AXIAL FORCE TO COMPRESS (LBS)	WEIGHT (LBS)	3D Model (.stp)
		2"	F020H308T3002	15"	175	28	
		2 1/2"	F024H308T3002	15"	350	33	
		3"	F030H308T3002	15"	225	38	
		4"	F040H308T3002	15"	575	46	
		5"	F050H308T3002	15"	350	60	
		6"	F060H308T3002	15"	400	74	
		8"	F080H308T3002	15"	575	111	
		10"	F100H308T3002	15"	850	147	
		12"	F120H308T3002	15"	475	199	

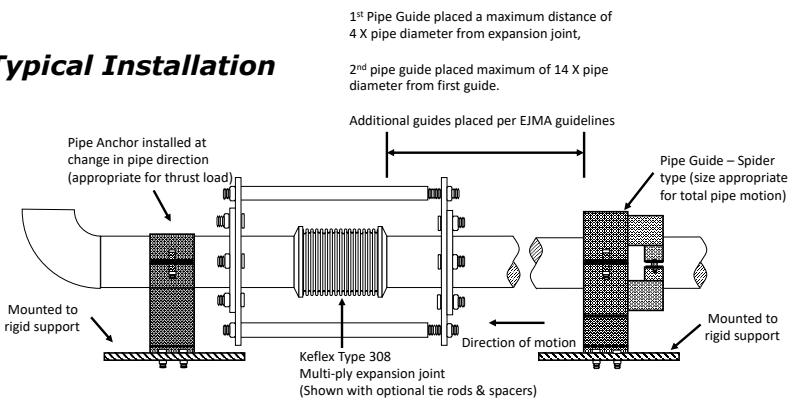
### Typical Installation



IMPORTANT LINKS	
BROCHURE:	
INSTALLATION INSTRUCTIONS:	
TECHNICAL DATA:	
WEBSITE:	<a href="http://FLEX-WELD.COM">FLEX-WELD.COM</a>

 **MADE IN THE USA**

**1425 LAKE AVE  
WOODSTOCK, IL 60098  
800-323-6893**