



HVAC Products

SUBMITTAL

Mar 2018

311 SERIES DUAL EXPANSION JOINT 4" TRAVEL W/WELD ENDS & TIE RODS

PROJECT:	
CUSTOMER:	
ENGINEER:	
ARCHITECT:	

MATERIALS OF CONSTRUCTION	
'A' PIPE SCH 40:	CARBON STEEL
'B' CAPSULE:	T-304 STN STL
'C' TIE RODS/SPACERS:	CARBON STEEL
'D' PLATE FLANGES:	CARBON STEEL

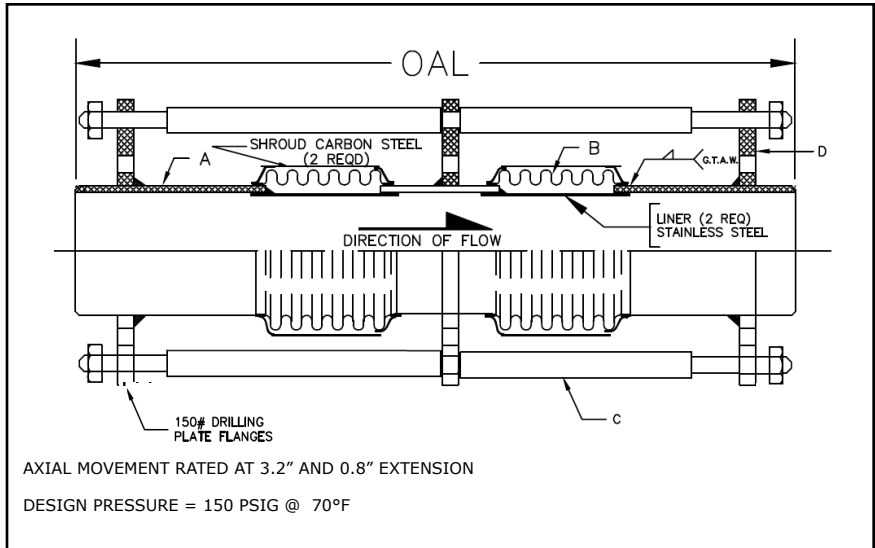

QTY	ID # OR TAG #	DIA (IN)	KEFLEX PART #	OAL	AXIAL FORCE TO COMPRESS (LBS)	WEIGHT (LBS)	3D Model (.stp)
		2"	F020M311DT904	31"	175	48	
		2 1/2"	F024M311DT904	31"	350	51	
		3"	F030M311DT904	31"	225	75	
		4"	F040M311DT904	31"	575	95	
		5"	F050M311DT904	31"	350	115	
		6"	F060M311DT904	31"	400	132	
		8"	F080M311DT904	31"	575	177	
		10"	F100M311DT904	31"	850	221	
		12"	F120M311DT904	31"	475	300	

Typical Installation

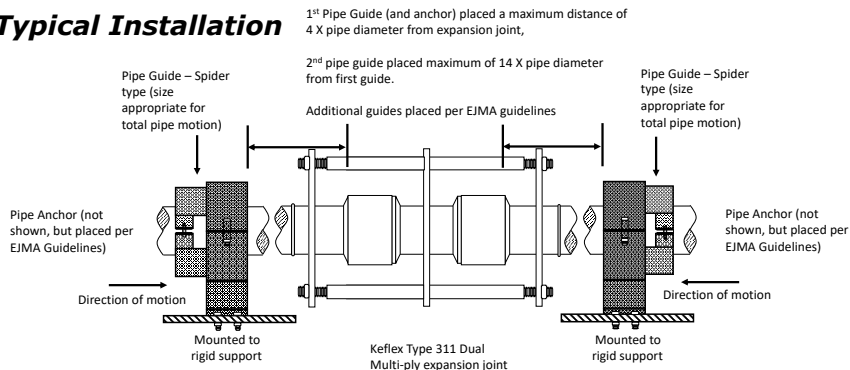

IMPORTANT LINKS

BROCHURE:	
INSTALLATION INSTRUCTIONS:	
TECHNICAL DATA:	
WEBSITE:	FLEX-WELD.COM



MADE IN THE USA

**1425 LAKE AVE
WOODSTOCK, IL 60098
800-323-6893**