



HVAC Products

SUBMITTAL

Mar 2018

308 SERIES EXPANSION JOINT 2" TRAVEL W/150# PLATE FLANGES & TIE RODS

PROJECT:	
CUSTOMER:	
ENGINEER:	
ARCHITECT:	

MATERIALS OF CONSTRUCTION	
'A' PIPE SCH 40:	CARBON STEEL
'B' CAPSULE:	T-304 STN STL
'C' PLATE FLANGE:	CARBON STEEL
'D' TIE RODS/SPACERS	CARBON STEEL

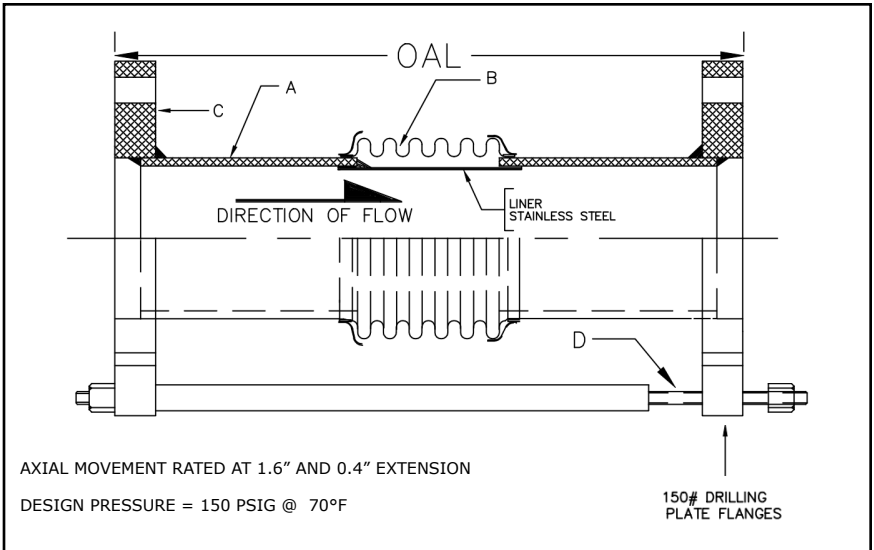

QTY	ID # OR TAG #	DIA (IN)	KEFLEX PART #	OAL	AXIAL FORCE TO COMPRESS (LBS)	WEIGHT (LBS)	3D Model (.stp)
		2"	F020M308T1502	15"	175	28	
		2 1/2"	F024M308T1502	15"	350	33	
		3"	F030M308T1502	15"	225	38	
		4"	F040M308T1502	15"	575	46	
		5"	F050M308T1502	15"	350	60	
		6"	F060M308T1502	15"	400	74	
		8"	F080M308T1502	15"	575	111	
		10"	F100M308T1502	15"	850	147	
		12"	F120M308T1502	15"	475	199	

Typical Installation

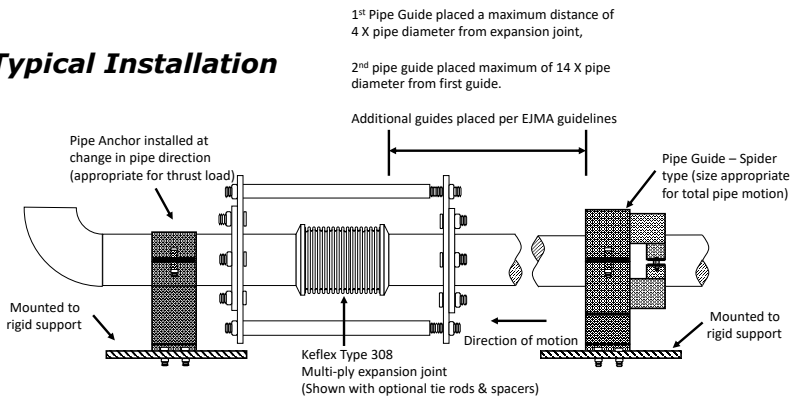

IMPORTANT LINKS	
BROCHURE:	
INSTALLATION INSTRUCTIONS:	
TECHNICAL DATA:	
WEBSITE:	FLEX-WELD.COM

MADE IN THE USA

**1425 LAKE AVE
WOODSTOCK, IL 60098
800-323-6893**