



HVAC Products

SUBMITTAL

Mar 2018

308 SERIES DUAL EXPANSION JOINT 4" TRAVEL W/300# PLATE FLANGES

PROJECT:	
CUSTOMER:	
ENGINEER:	
ARCHITECT:	

MATERIALS OF CONSTRUCTION	
'A' PIPE SCH 40:	CARBON STEEL
'B' CAPSULE:	T-304 STN STL
'C' BASE PLATE:	CARBON STEEL
'D' PLATE FLANGES:	CARBON STEEL

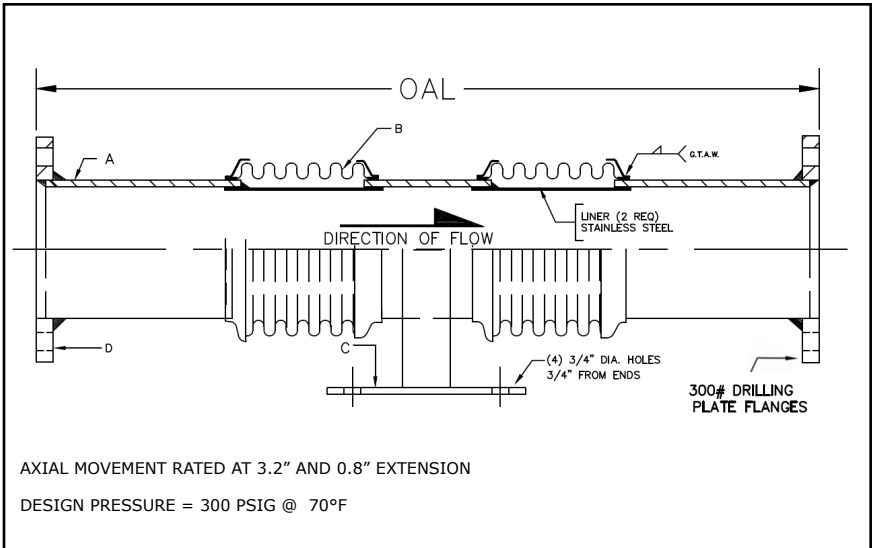

QTY	ID # OR TAG #	DIA (IN)	KEFLEX PART #	OAL	AXIAL FORCE TO COMPRESS (LBS)	WEIGHT (LBS)	3D Model (.stp)
		2"	F020H308DB3004	24"	175	30	
		2 1/2"	F024H308DB3004	24"	350	32	
		3"	F030H308DB3004	24"	225	56	
		4"	F040H308DB3004	24"	575	81	
		5"	F050H308DB3004	24"	350	98	
		6"	F060H308DB3004	24"	400	114	
		8"	F080H308DB3004	24"	575	152	
		10"	F100H308DB3004	24"	850	195	
		12"	F120H308DB3004	24"	475	264	

Typical Installation

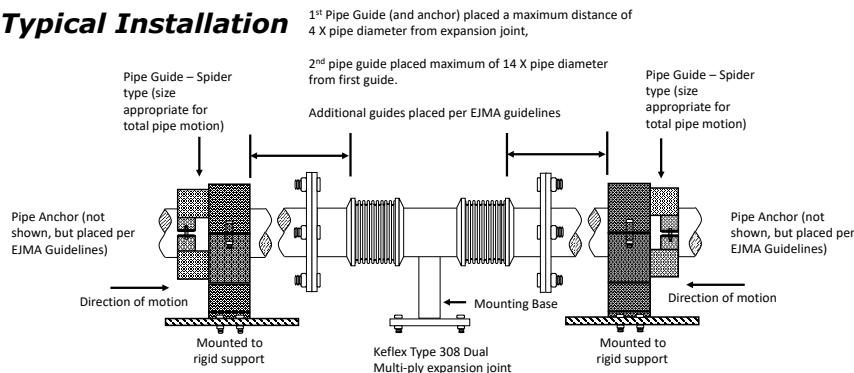

IMPORTANT LINKS

BROCHURE:	
INSTALLATION INSTRUCTIONS:	
TECHNICAL DATA:	
WEBSITE:	FLEX-WELD.COM



MADE IN THE USA

1425 LAKE AVE
WOODSTOCK, IL 60098
800-323-6893